

KD-BYOD4K

4K KDPlay Wireless Presentation Gateway for PC, Mac, iOS, Android, and Chrome OS devices. Full and Multi-Presenter Viewing Modes. Screen Mirroring via LAN or WiFi with built-in Antenna. Power over Ethernet, HDMI and Analog Audio Output, USB Keyboard, Mouse, and Annotation Control



Key digital®

The Experts in Digital Video Technology and Solutions™

Table of Contents

About KD-BYOD4K	3
WiFi Direct vs WiFi Client vs LAN Connection Modes	5
Network Security & Considerations	6
Quick Setup Guide	8
Cabling	8
Configuration	9
Cast	19
Custom Home Screen Image	25
Application Examples	26
Admin Menu Walkthrough	29
Warranty Information	39
Product Warning & Safety Instructions	39



Default IP Address: 192.168.13.1

Quick Setup Guide

Please visit www.keydigital.com for the latest product documentation, firmware, control drivers and software downloads. Product features and specifications are subject to change without notice

Always follow the instructions provided in this Operating Manual.

About KD-BYOD4K

KD-BYOD4K wireless presentation gateway for the KDPlay™ system enables presenters to cast content to their display or projector from their Windows, Mac, or Chrome OS laptops, iPads, iPhones, Android tablets or phones via WiFi. Multiple attendees may cast simultaneously, encouraging teachers and students, trainers and participants, all to collaborate regardless of their connection type and without the hassle of wires. KD-BYOD4K features annotation, moderator management and touchscreen/mouse control for a true interactive experience. Easily load KDPlay™ application onto your laptop from the unit's web page or plug in the included KDPlay Flash™ to auto launch. Additional Flash™ may be purchased separately. Android users download the KDPlay™ app, iOS devices natively cast using AirPlay, and Chrome OS devices cast desktop or tabs from Chrome browser. KD-BYOD4K's dual network ports enable access via Employee and Guest network for easy internet access. KD-BYOD4K supports 4K output resolution as well as full-screen or auto sizing multi-presenter viewing modes.

Key Features

- **Wireless Presentation Gateway:** Connect via WiFi to wirelessly cast content from device.
- **Bring Your Own Device:** Cast from Windows and Mac computers or Android devices using KDPlay™ software and app. Cast from iOS devices with AirPlay. Cast from Chrome OS using Chrome browser tool for tablet or desktop.
- **Multi-Presenter Mode:** Up to four presenters may share content at same time with auto adjusting screen layout. User preference layout setup for three or four presenters allows for optimal window placement based on usage.
- **Easy Connection:** Up to 16 simultaneous devices may connect, with access always provided to new connecting devices and automatic disconnect of oldest non-casting devices in case of maximum being reached.
- **KDPlay™ Flash Included:** Software auto-launcher with USB and USB-C connections allows Additional KDPlay™ Flash sold separately.
- **4K/UHD Source & Display:** Supports incoming signals and outputs at 4K/UHD for optimal clarity of spreadsheets and data content.
- **Annotation and White Board:** Screen overlay tools for real-time collaboration. Screen captures are downloaded by QR code or in web browser.
- **Extended Monitor:** Feature enables dual display setups such as video conference and presentation content view on side-by-side panels.
- **WiFi Direct, WiFi Client, LAN Connection Modes:** May act as the Wireless Access Point or may be accessed by devices via the wired or wireless network connection.
- **Content Preview:** Collapsible dock on side of display provides preview thumbnail and name of devices casting via KDPlay™ app.
- **Touch Screen / Mouse Forwarding:** Connect touchscreen or mouse USB to unit to point and click on casted device.

- **Moderator Management:** Administrator may start & stop device casting via web control page.
- **Web GUI Administration:** Access unit setup, moderator, and security tools on web browser through LAN.
- **Four-Level Security:** Including casting / pairing pin and Device-type permission options, AES-256 + RSA-1024 encryption.
- **Simultaneous Secure Dual Network:** Two network ports enable concurrent connection to Public and Private networks for ease of guest access without compromising security.
- **Video Resolution:** Selectable 4K 3840x2160 @ 30fps or 60fps [4:2:0] 10.2Gbps, 1920x1080p @ 60fps, 1920x1200p @ 60fps, 1280x800p @ 60fps, 1280x720p @ 60fps output resolution options based on EDID from connected display.
- **Audio De-embedding:** Audio of the casted device is de-embedded at the unit's analog L/R audio connector for ease of integrating with audio amplification and mixing systems.

Features Table

	Casting Method	Video	Audio	Max Simultaneous Casting Devices	Mouse Forwarding	Moderator Preview
Windows	KDPlay app	YES	YES	4	YES	YES
Windows	Chromecast (Chrome browser)	YES	YES	2		
MacOS	KDPlay app	YES	YES	4	YES	YES
MacOS	AirPlay	YES	YES	2		
MacOS	Chromecast (Chrome browser)	YES	YES	2		
Android	KDPlay app	YES		4		YES
iOS	AirPlay	YES	YES	2		
Chrome OS	Chromecast (Chrome browser)	YES	YES	2		

*Video content from streaming services such as Amazon & HBO & Netflix not supported due to copy protection.

**Device types have additional notes on setup requirements or limitations. See [Casting](#) section for more info.

WiFi Direct vs WiFi Client vs LAN Connection

Which Mode of Operation Is Best for Your Installation?

WiFi Direct Mode (Default) allows wireless devices direct access to the base unit using KD-BYOD4K's built-in WiFi access point. WiFi Direct Mode is the quickest way to begin casting to your KDPlay™ screen but only provides internet to connected devices if a LAN wire is connected from an internet enabled network.

WiFi Direct Mode with no Internet Connection



WiFi Direct Mode with Internet Connection



WiFi Client Mode allows connection to external WiFi Router without network cable. Wireless devices access the base unit via wireless or wired connection into the LAN. WiFi Direct mode is disabled when WiFi Client Mode is enabled.



LAN Connect Mode requires KD-BYOD4K be wired into your local network. Wireless devices access KD-BYOD4K via your existing external WiFi network therefore allowing users to stay connected to an internet enabled network(s). WiFi Direct mode is disabled when LAN Connect Mode is enabled.



Network Security & Considerations

Bandwidth

- The maximum bandwidth per casted device is 12Mbps per stream. Common usage will be 12 – 48Mbps for one to four presenters.

Security

- KD-BYOD4K’s dual LAN ports enable concurrent connection to two networks. Connected networks are completely isolated from each other, providing ease of access without compromising security. Additional network security settings may be adjusted in the Admin Access page.
- Use security level 3 or the Preference setting to apply encryption to all casting data if you have any security concerns.

Security Settings

Security Level

#	Security Item	Level 1	Level 2	Level 3	Preference
1	Enable login password for Webpage	✓	✓	✓	✓
2	Auto-change password for Wireless	✓	✓	✓	✓
3	Encryption of Data: Proprietary	✓	✓	✓	✓
4	Enable "Airplay" PIN code		✓	✓	<input type="checkbox"/>
5	Enable login password for Telnet		✓	✓	<input type="checkbox"/>
6	Encryption of Data: AES-256 Bit + RSA-1024Bit		✓	✓	<input type="checkbox"/>
7	Disable Android APK,Airplay			✓	<input type="checkbox"/>
8	Disable "Firmware downgrade"			✓	<input type="checkbox"/>

Current Security Level: Level 1 Level 2 Level 3 Preference

SAVE

Firewall Settings

In most installations, there are no network settings that need to be applied for common functionality.

However, if you are installing KD-BYOD4K on an advanced network, please ensure that the below list of TCP and UDP port numbers remains open on your network in order for devices to cast to KD-BYOD4K.

	TCP Port #	UDP Port #	Casting IP Address
KDPlay App Windows, MacOS	20000, 20002, 20003, 20006, 20007, 20008, 20009, 20010	6667, 8887, 8889 20005	IP Multicast Group Address: 239.1.1.1 Broadcast IP address: 255.255.255.255
KDPlay App Android	8121, 48689 51030, 51040, 52020, 52030 Additional Port #'s Possible	8887, 8889	IP Multicast Group Address: 239.1.1.1 Broadcast IP address: 255.255.255.255
AirPlay iOS	5656, 51010, 51020 17011, 17012, 17100	5353	MDNS: 224.0.0.251
Chromecast	8008	1900, 5353, 8009 16660, 16661, 16662, 16663	SSDP: 239.255.255.250 MDNS: 224.0.0.251 Note: Casting device and KD-BYDO4K must be within in same subnet.
Web Browser	80		

KD-BYOD4K LAN Port Features

In most installations, there are no network settings that need to be applied for common functionality.

	PoE	Maximum Bandwidth
LAN Port 1		100Mbps
LAN Port 2	YES	1Gbps

Quick Setup Guide

Begin with KD-BYOD4K, the connected display / touch screen monitor, and all USB or HDMI extension devices turned off with power cables removed. Ensure that all desired functionality is achieved before installing. **Do not connect phoenix block into “Factory Only” port or audio loss will be experienced.**

Cabling

Cabling for WiFi Direct Mode

1. Connect KD-BYOD4K to an HDMI display.
2. (Optional) Connect mouse or touch screen monitor to USB 2.0 port if using content preview dock, annotation, or chalkboard tools. USB 3.0 and USB-C connections are available as well.
3. (Optional) Connect audio from L/R output to audio amplifier.
4. Connect power to KD-BYOD4K unit



Cabling for WiFi Client Mode

1. Connect KD-BYOD4K to an HDMI display.
2. (Temporary – Initial Setup Only) Connect network cable from WiFi Router / Network Switch.
3. (Optional) Connect mouse or touch screen monitor to USB 2.0 port if using content preview dock, annotation, or chalkboard tools. USB 3.0 and USB-C connections are available as well.
4. (Optional) Connect audio from L/R output to audio amplifier.
5. Connect Power to KD-BYOD4K unit (if not using PoE as described in step 2a).



Cabling for LAN Connection Mode

1. Connect KD-BYOD4K to an HDMI display.
2. Connect network cable from WiFi Router / Network Switch.
 - a. (Optional) Connect to KD-BYOD4K's LAN 2 port to power the unit via PoE from a supported network switch
 - b. (Optional) You may connect KD-BYOD4K to two networks for concurrent access to KD-BYOD4K from devices on each network.
3. (Optional) Connect mouse or touch screen monitor to USB 2.0 port if using content preview dock, annotation, or chalkboard tools. USB 3.0 and USB-C connections are available as well.
4. (Optional) Connect audio from L/R output to audio amplifier.
5. Connect Power to KD-BYOD4K unit (if not using PoE as described in step 2a).



Configure

How to Configure for WiFi Direct Mode with Web UI

1. Connect to network named KD-BYOD4K-XXXX. The password is displayed on the HDMI connected monitor and the default password is **12345678**
2. Open web browser, and enter 192.168.13.1 in the address bar
3. Press the **ADMIN ACCESS** button at top-right of the page
4. Enter default password **admin**
5. Enter **NETWORK** menu and choose **Wireless** sub-menu
6. Enter the desired name (SSID) for KD-BYOD4K's WiFi network. The default network name is KD-BYOD4K-XXXX
7. Enter the desired password for KD-BYOD4K's WiFi network. Letters and numbers are allowed. Special characters are not supported. The default password is **12345678**.
8. **SAVE** changes
9. **Note:** If you change the password but not the SSID (network name), you may have to forget and re-join the network to re-connect.

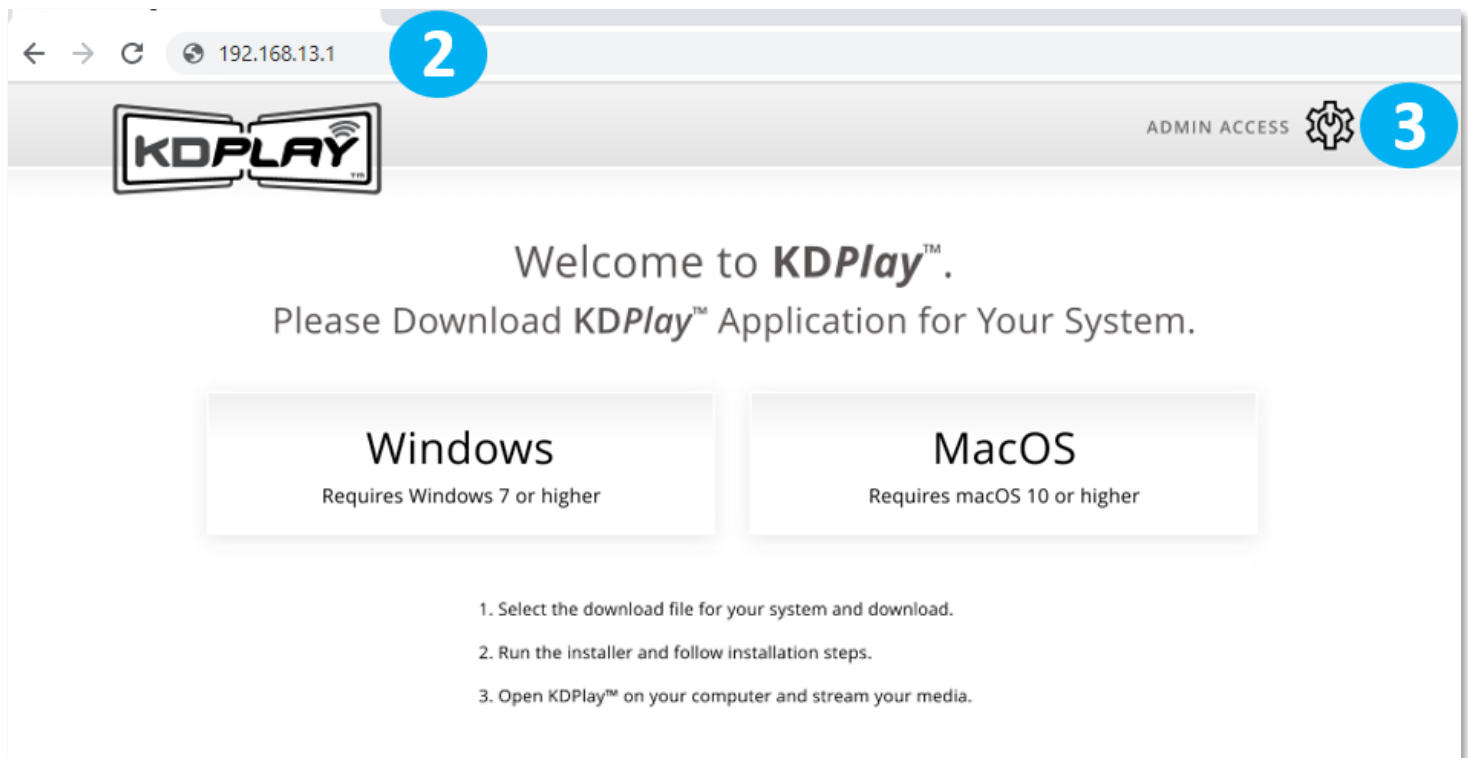

The screenshot shows a web browser window with the address bar containing '192.168.13.1' and a blue circle with the number '2' next to it. The page header features the 'KDPLAY' logo on the left and 'ADMIN ACCESS' with a gear icon and a blue circle with the number '3' on the right. The main content area displays 'Welcome to KDPlay™' and 'Please Download KDPlay™ Application for Your System.' Below this are two buttons: 'Windows' (Requires Windows 7 or higher) and 'MacOS' (Requires macOS 10 or higher). At the bottom, there are three numbered instructions: 1. Select the download file for your system and download. 2. Run the installer and follow installation steps. 3. Open KDPlay™ on your computer and stream your media.



ADMIN ACCESS 

Welcome to **KD-BYOD4K**, Wireless Presentation Switcher

Please Enter Device Password: **4**

Windows

Requires Windows 7 or higher

MacOS

Requires macOS 10 or higher

Android

Requires Android 5.0 or higher

Operation Manual

Requires PDF Viewer



LOGOUT 

Network Wireless Settings

5 NETWORK

- > Network Mode
- > **Wireless**
- > Ethernet (LAN)

DISPLAY & AUDIO

SYSTEM

SECURITY

F/W UPDATE

DEVICE INFO

WiFi Direct Mode | LAN Connection Mode

Network Name (SSID): **6**

Security: WPA/WPA2 - Personal (Recommended)

Frequency: 2.4 Ghz 5 Ghz

Auto Change Password:

Password: **7**

Channel Width: [text]

Channel:

8

How To Configure for WiFi Client Mode with Web UI

IMPORTANT: You must first connect a cable from your network to KD-BYOD4K for the unit to collect network information. This is temporary, as WiFi client mode will not require a LAN cable connection for final installation.

1. Confirm that KD-BYOD4K has been provided an IP address from your Local Area Network as shown on the top-left corner of KD-BYOD4K's home screen.
2. Join that same Local Area Network on the laptop / setup device.
3. Open web browser and enter the KD-BYOD4K's IP address in the address bar to access the Web UI.
4. Press the **ADMIN ACCESS** button at top-right of the page. Enter default password **admin** and the Admin Menu loads.
5. With WiFi Direct Mode still chosen, enter the **WIRELESS** sub-menu and enter the desired name for the KD-BYOD4K unit (example "Conference Room") in the **Network Name (SSID)** cell. Press **SAVE**. The default name is KD-BYOD4K-XXXX. The password is displayed on the HDMI connected monitor and the default password is **12345678**for casting .
6. Re-enter the **NETWORK MODE** sub-menu.
7. Choose **WiFi Client Mode** and confirm to apply.
8. Enter the **Wireless** sub-menu and the **WiFi Client / LAN Connection Mode** tab
9. Choose **2.4 Ghz or 5 Ghz** frequency and press **WIRELESS SCANNER** to begin scanning for the WiFi Network that you have connected the KD-BYOD4K unit to.
10. Choose your desired WiFi Network and press **SAVE**.
11. Enter the WiFi Password and press **CONNECT**.
12. After the connection status bar completes, press **SAVE** at the bottom-center of the page.
13. Ensure that the KD-BYOD4K home screen displays its IP address and proper WiFi network's name.

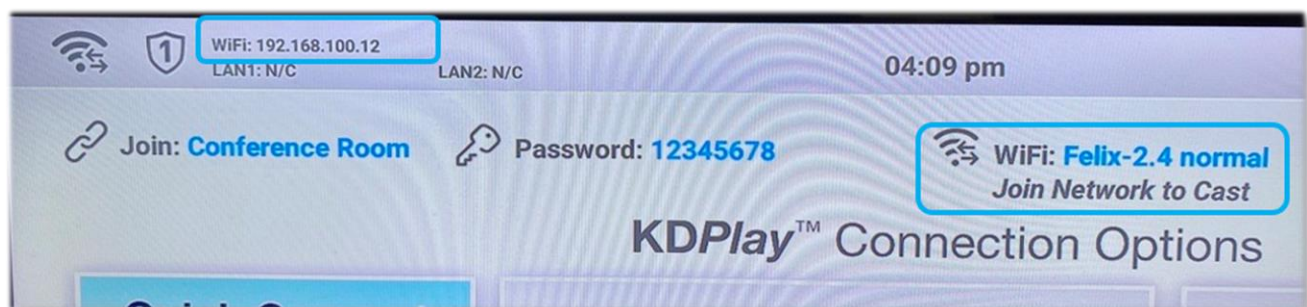

14. You may now disconnect the network cable from the LAN port and install KD-BYOD4K at the desired display / projector location.

KDPLAY LOGOUT

Network Wireless Settings

NETWORK

- > Network Mode
- > **Wireless**
- > Ethernet (LAN)

DISPLAY & AUDIO

SYSTEM

SECURITY

F/W UPDATE

DEVICE INFO

WIFI Direct Mode | **WiFi Client / LAN Connection Mode**

Network Name(SSID): Conference Room **5**

Security: WPA/WPA2 - Personal (Recomr)

Frequency: 2.4GHz 5GHz

Auto Change Password: Never

Password: 12345678

Channel Width: Auto

Channel: 36

SAVE

KDPLAY LOGOUT

Network Mode Setting

Current Network Mode: **WiFi Direct Mode** Device Name(SSID): **KD-BYOD4K-4540**

WiFi Direct Mode

WiFi Direct Mode allows wireless devices direct access to the base unit. Any additional wireless devices on the local network can access the base unit via LAN if it is connected to a wired local network.

7 **WiFi Client Mode**

WiFi Client Mode allows connection to external WiFi Router without network cable. WiFi Direct Mode will be disabled. Wireless devices access the base unit via wireless or wired connection into the LAN.

KOPLAY

Network Wireless Settings

WIFI Direct Mode | **WiFi Client / LAN Connection Mode**

Frequency: 2.4GHz 5GHz

WIRELESS SCANNER **9**

SSID:

Password:

CONNECT

Connection: No Connection

Available WiFi Networks RESCAN

ID	SSID	Signal
<input type="radio"/> 1	INFINITUM1FD7	Signal strength indicator
<input checked="" type="radio"/> 2	Felix-2.4 normal	Signal strength indicator
<input type="radio"/> 3	Telcel-6686	Signal strength indicator
<input type="radio"/> 4	Sankofa	Signal strength indicator
<input type="radio"/> 5	Default	Signal strength indicator
<input type="radio"/> 6	INFINITUM1035	Signal strength indicator
<input type="radio"/> 7	TP-Link_SCD0	Signal strength indicator

SAVE **10**

KOPLAY LOGOUT

Network Wireless Settings

WIFI Direct Mode | **WiFi Client / LAN Connection Mode**

Frequency: 2.4GHz 5GHz

WIRELESS SCANNER

SSID:

Password:

CONNECT **11**

Connection: Connected

SAVE **12**

How to Configure for LAN Connection Mode with Web UI

6. Connect to wireless network named KD-BYOD4K-XXXX. The password is displayed on the HDMI connected monitor and the default password is **12345678**.
7. Open web browser, enter 192.168.13.1 in the address bar
8. Press the **ADMIN ACCESS** button at top-right of the page
9. Enter default password **admin**
10. Enter **NETWORK** menu and choose **Network Mode** sub-menu
11. Choose **LAN Connection Mode** and confirm to apply. Wait a few moments for the new setting to apply.
12. Reconnect to unit, by entering the IP address shown on the HDMI connected monitor in your browser address bar.
13. Enter the **Wireless** sub-menu and the **LAN Connection Mode** tab
14. Enter the desired name (SSID) for KD-BYOD4K's Play Screen. The default network name is KD-BYOD4K-XXXX
15. Enter the desired password for casting to KD-BYOD4K's Screen. The password is displayed on the HDMI connected monitor and the default password is **12345678**
16. Choose **2.4 Ghz or 5 Ghz** frequency and press **WIRELESS SCANNER** to begin scanning for the WiFi Network that you have connected the KD-BYOD4K unit to.
17. Choose your desired WiFi Network and press **SAVE**
18. Enter the WiFi Password and press **CONNECT**. Press **SAVE** and verify **Connection Status**
19. (Optional) To set a desired static IP address to KD-BYOD4K, enter the Ethernet LAN sub-menu. The default IP address setting for LAN Connection Mode is DHCP / Obtain IP Address Automatically. Press **SAVE** to apply new settings.

LOGOUT

- NETWORK**
 - 5** Network Mode
 - Wireless
 - Ethernet (LAN)
- DISPLAY & AUDIO
- SYSTEM
- SECURITY
- F/W UPDATE
- DEVICE INFO

Network Mode Settings

Current Network Mode: **WiFi Direct Mode** Device Name (SSID): **My Conference Room**

WiFi Direct Mode



WiFi Direct Mode allows wireless devices direct access to the base unit. Any additional wireless devices on the local network can access the base unit via LAN if it is connected to a wired local network.

6 LAN Connection Mode



LAN Connection Mode allows direct connection to wired local network via LAN. WiFi Direct Mode will be disabled. Wireless devices can only access the base unit via external WiFi Router on the same network.

SAVE

LOGOUT

- NETWORK**
 - Network Mode
 - 8** Wireless
 - Ethernet (LAN)
- DISPLAY & AUDIO
- SYSTEM
- SECURITY
- F/W UPDATE
- DEVICE INFO

Network Wireless Settings

WiFi Direct Mode **LAN Connection Mode**

KD-BYOD4K Name(SSID): **9**

KD-BYOD4K Password: **10**

Note: You must connect a network cable to the KD-BYOD4K unit.

Frequency: 2.4GHz 5GHz

11 **WIRELESS SCANNER**

SSID: --

Password: **CONNECT**

Connection: No Connection

SAVE

Available WiFi Networks

ID	SSID	Signal
1	KDS-LAB-TEST	Signal strength indicator
2	Lab_Extreme	Signal strength indicator
3	Cisco11943	Signal strength indicator
4	LinksysE900Recording	Signal strength indicator
5	KDQC_Station1	Signal strength indicator
6	Verizon-791L-749A	Signal strength indicator
7	04PX1	Signal strength indicator
8	49MSG	Signal strength indicator
9	Keydigital	Signal strength indicator
10	CompassTrainingRacks	Signal strength indicator

SAVE

Network Wireless Settings

WiFi Direct Mode | LAN Connection Mode

Frequency: 2.4 Ghz 5 Ghz

WIRELESS SCANNER

SSID: KDS-LAB-TEST

Password: 12345678

Connection Status:

SAVE

KOPLAY LOGOUT

NETWORK
- Network Mode
- Wireless
- Ethernet (LAN)

DISPLAY & AUDIO

SYSTEM

SECURITY

F/W UPDATE

DEVICE INFO

Network Ethernet (LAN) Settings

LAN 1 | LAN 2

Obtain Address Automatically | Use the following IP address:

IP Address: 192.168.1.100

Subnet Mask: 255.255.0.0

Default Gateway: 192.168.1.1

DNS 1: 192.168.1.20

DNS 2:

MAC Address: 60:89:B1:37:10:01

SAVE

Cast

1. Power on connected HDMI display and select the appropriate HDMI input connection. All instructions are displayed on KD-BYOD4K's Home Screen



2. (Preferred Method) Casting with KDPlay Flash Auto-Launcher from PC / Mac

Note: If casting for the first time after changing network settings, please pair KDPlay Flash with KD-BYOD4K as instructed below

- a. Insert KDPlay Flash drive into computer. KDPlay software will auto launch.
- b. Press **START MIRRORING** to begin casting your content.
- c. Press the **GEAR ICON** to enter the Settings for Volume, Extended Display, and more.



How to Pair KPlay Flash with KD-BYOD4K

The included KPlay Flash is pre-paired with the KD-BYOD4K unit



- To pair, plug KPlay Flash into any USB port on KD-BYOD4K and wait for success confirmation on screen.
- When is Pairing necessary?
 - After changing network mode or network settings
 - After factory default reset of unit
 - After firmware update of unit

Notes for using MacOS with KDPlay Flash

MacOS Monterey users must go to SECURITY & PRIVACY → SCREEN RECORDING to ensure that KDPlay is allowed to record the contents of their screen.

MacOS Catalina is required to support auto-launch feature of KDPlay Flash

Older OS versions like Mojave may require that you re-boot the computer after initially running the KDPlay .exe

Users may manually run KDPlay software or use AirPlay if they do not wish to upgrade to MacOS Catalina.

For Extended Monitor from MacOS, use AirPlay and select “Use as Separate Display”.

When inserting KDPlay Flash into Mac computer, the following message is received. Press OK to all access

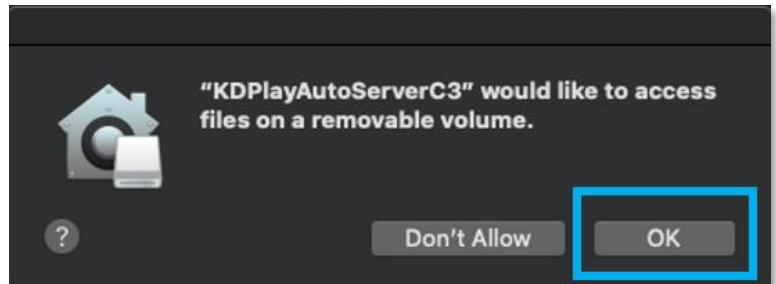

3. Casting from PC / Mac computer:

- Ensure that you are connected to appropriate WiFi network, as instructed on Home Screen.
- Open web browser, and enter KD-BYOD4K's IP Address, as displayed on Home Screen on your display/projector.
- On Welcome Page, press button to download *KDPlay™* software for Windows or macOS X.
- Run the *KDPlay.exe* file to open *KDPlay™* software.
- Choose desired *KDPlay* screen you wish to cast to. Press **CONNECT** button.
- Enter the KD-BYOD4K device's password, as displayed on Home Screen.
- Press **CONNECT** button. You are now paired with the KD-BYOD4K device, but not yet Casting.
- Press **START MIRRORING** to begin casting your content.
- Press the GEAR ICON to enter the Settings for Volume, Extended Display, and more.

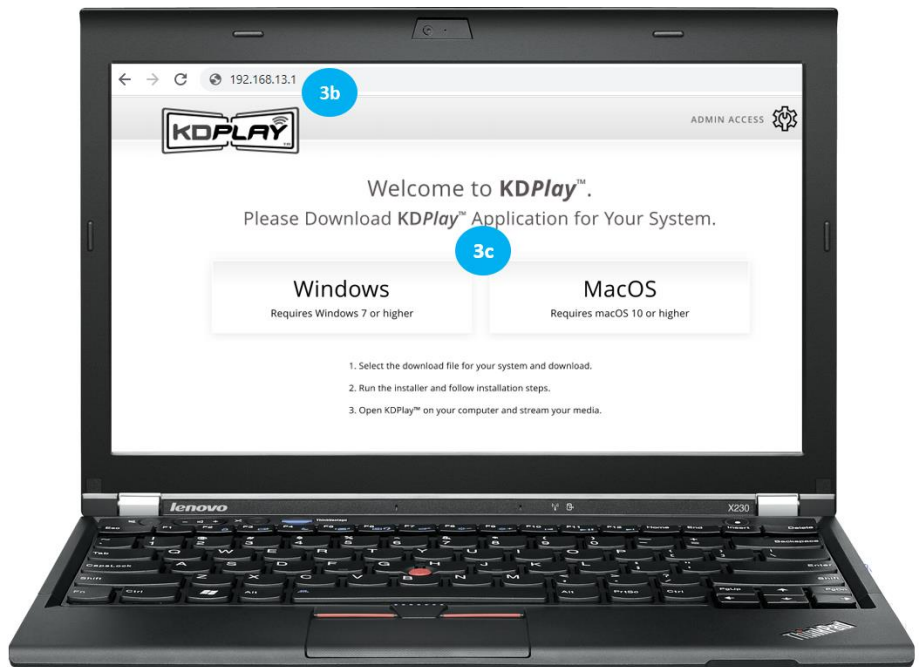

- a. Note: Using the PC's volume controls on the keyboard will result in casted audio + audio on the PC's speakers. Toggle mirroring to resume audio output only at the KD-BYOD4K display.

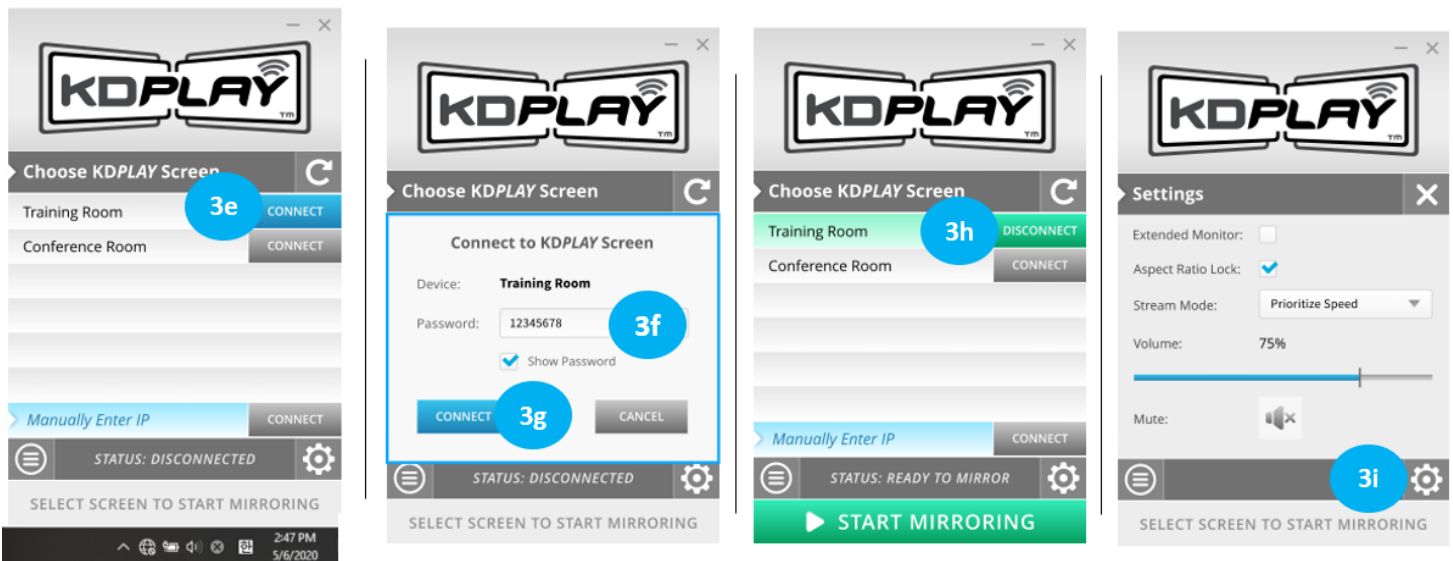

4. Casting from iOS Device:

- a. Ensure that you are connected to appropriate WiFi network, as instructed on Home Screen
- b. Open **Control Center** on iOS Device by dragging finger upward from bottom-center of screen.
- c. Choose **Screen Mirroring**
- d. Choose your KD-BYOD4K device you wish to cast to

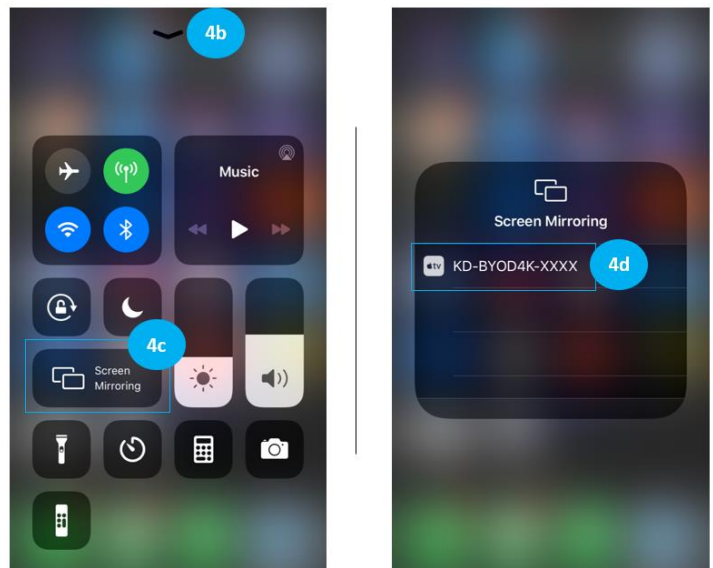

iOS Casting Notes

Streaming video from YouTube app via AirPlay is not currently support. Please stream from web browser if needed. Future updates may add YouTube app support. Two maximum iOS devices may simultaneously cast to KD-BYOD4K. Moderator preview not supported for devices casting without KDPlay app. If casting for the first time after changing network settings, it may be necessary to forget the KD-BYOD4K network and re-join, especially if you have updated the WiFi Direct Mode SSID password.

5. Casting from Android device:

- a. Open **Google Play** and download **KDPlay™** app
- b. Ensure that you are connected to appropriate WiFi network, as instructed on Home Screen.
- c. Run **KDPlay™** app
- d. Choose desired **KDPlay** screen you wish to cast to.
- e. Enter the KD-BYOD4K device's password, as displayed on Home Screen.
- f. Press **CONNECT** button. You are now paired with the KD-BYOD4K device, but not yet Casting.
- g. Press **START MIRRORING** to begin casting your content.

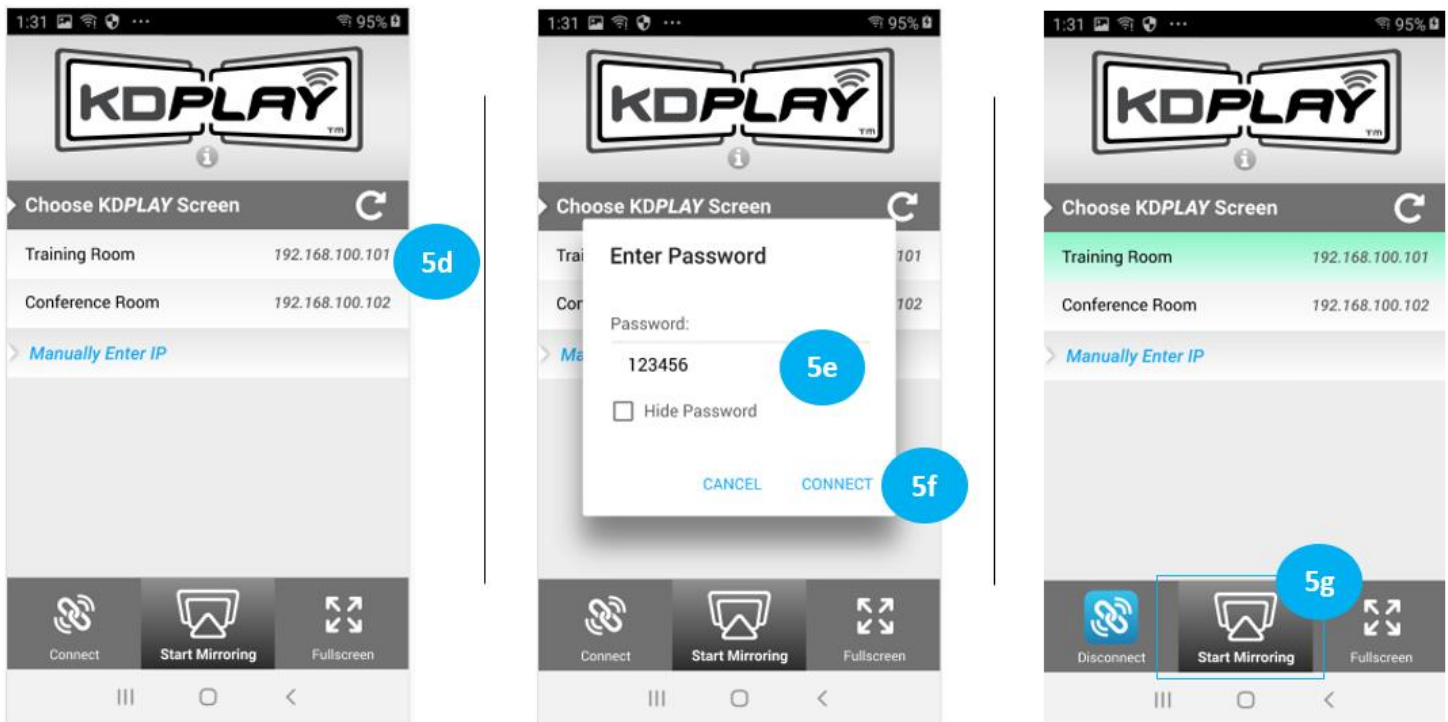

Android Casting Notes

Android currently supports video streaming only, not audio. Future updates may add audio streaming support. To reduce mobile device battery consumption, please disconnect from KD-BYOD4K and completely close the app when done using.

6. Casting from Chrome OS / Chrome Browser:

- a. Open Chrome browser.
- b. In top-right corner, press the vertical ellipsis “⋮” button and choose **Cast...**
- c. Select the desired **Share Source** (browser tab, desktop, or file) in the dropdown menu.
 - i. **Note:** Choose desktop if you wish to cast from YouTube.
- d. Click the KD-BYOD4K device you wish to cast to.
- e. You may now use the  casting icon to enter the Casting menu and toggle casting state.

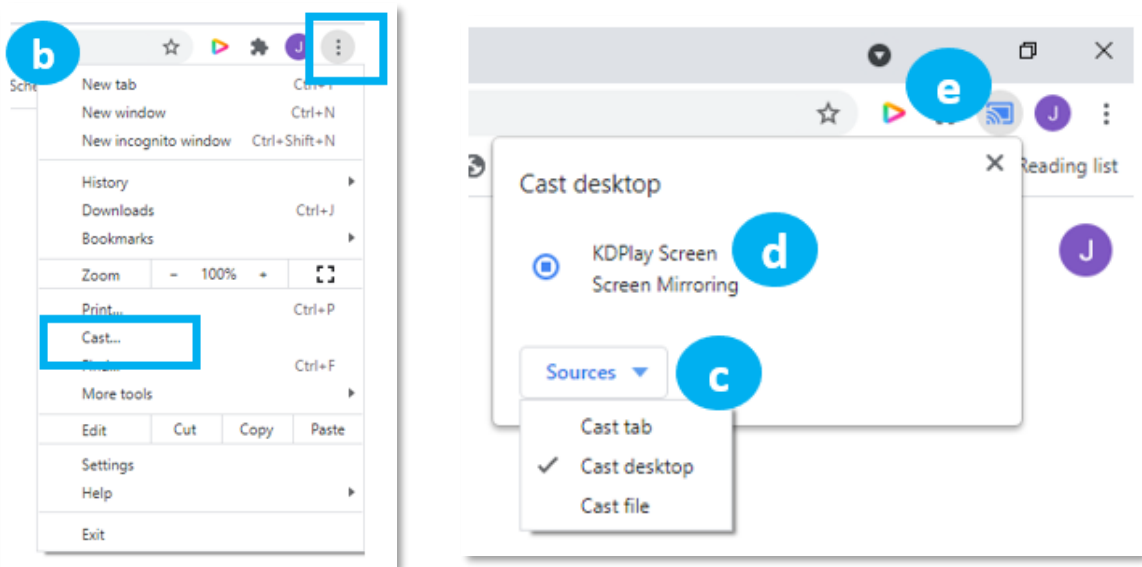

Chrome OS Casting Notes

Two maximum Chrome OS devices may simultaneously cast to KD-BYOD4K. For Chrome OS support, KD-BYOD4K must be on an internet-enabled network and the KD-BYOD4K time setting **Use Network-Provided Time** applied with correct time zone selected. The casting device must be in same subnet for chromecast casting. Power cycle KD-BYOD4K after updating time and/or network settings. If the updated device name is not shown after applying, close all existing Chrome browser sessions, power cycle KD-BYOD4K, and open a new browser window.

Moderator preview not supported for devices casting without KDPlay app.

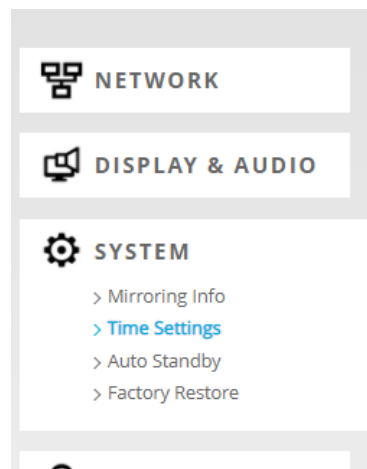

System Settings

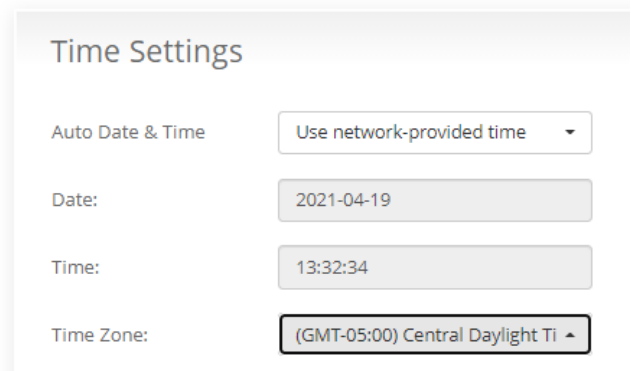

Custom Home Screen Image

A custom home screen background image may be loaded and selected

- Enter the **Admin Menu**, choose **Display & Audio**, and **Home Screen** background.
 - Press the "+" thumbnail to browse and choose your image.
 - The custom image must be 1920x1080 resolution with 72 dpi.
- **Lock Instructional Banner** setting is applied by default so KD-BYOD4K's connection information always appears at the top of the home screen.
- The Instructional Banner is 73 pixels tall. It may be necessary to adjust the vertical centering of your custom image to ensure the top part of the image is not covered by the instructional banner.
- White background colors will look cleanest.

The screenshot displays the KDPLAY web interface. On the left is a navigation menu with categories: NETWORK, DISPLAY & AUDIO (selected), SYSTEM, SECURITY, and F/W UPDATE. The main content area is titled 'Display & Audio Settings' and contains a 'Home Screen Background' section. This section shows a preview of a custom image with the text 'JOHNY BABY'S Heart Sauce' and a 'KDPLAY' logo in the top right. Below the preview is a checkbox labeled 'Lock instructional banner when using custom background image' which is checked. A 'Notes' section below the checkbox lists:

- Custom image must be 1920X1080 resolution with 72 dpi.
- Instructional banner is 73 pixels tall. You may need to adjust the vertical centering of your custom image if instructional banner is locked.

 To the right of the main interface is a separate window titled 'Custom Home Screen Example' showing the same 'Heart Sauce' image on a screen with the KDPLAY logo in the top right corner.

Application Examples

WiFi Direct Mode

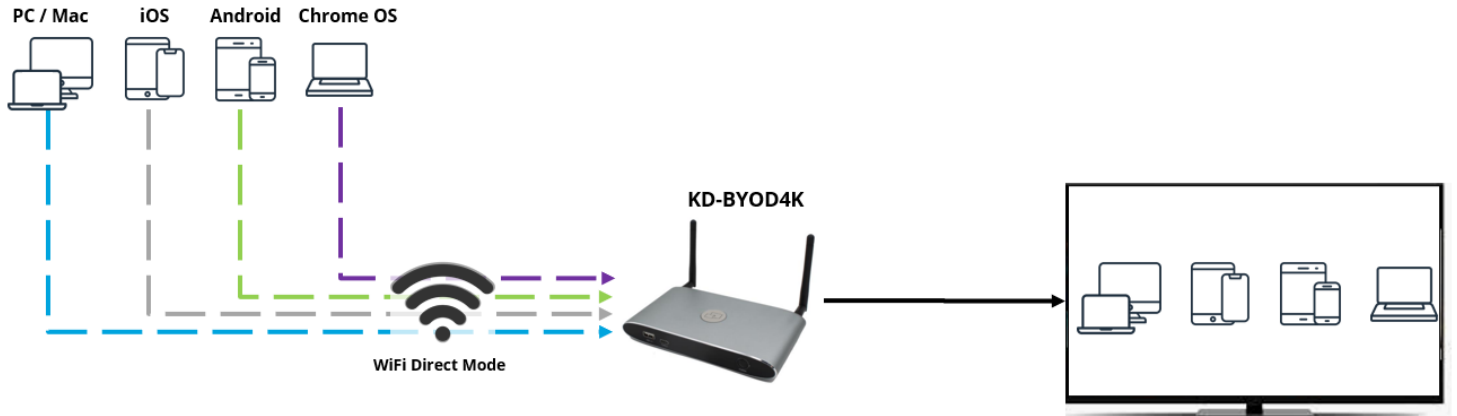

Touchscreen Annotation in LAN Connection Mode

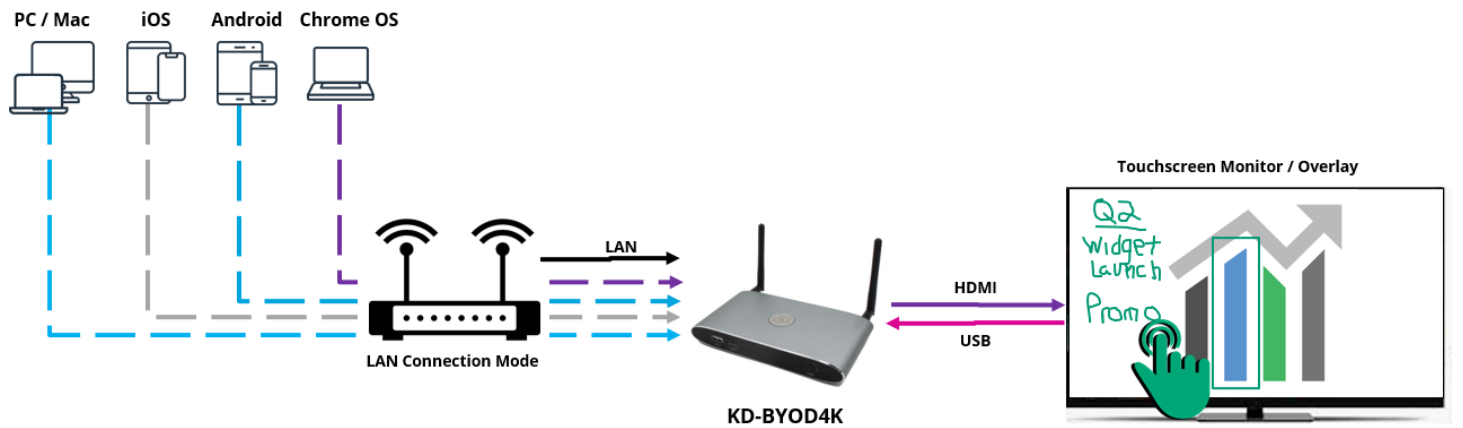

Audio De-Embedding and USB Extension

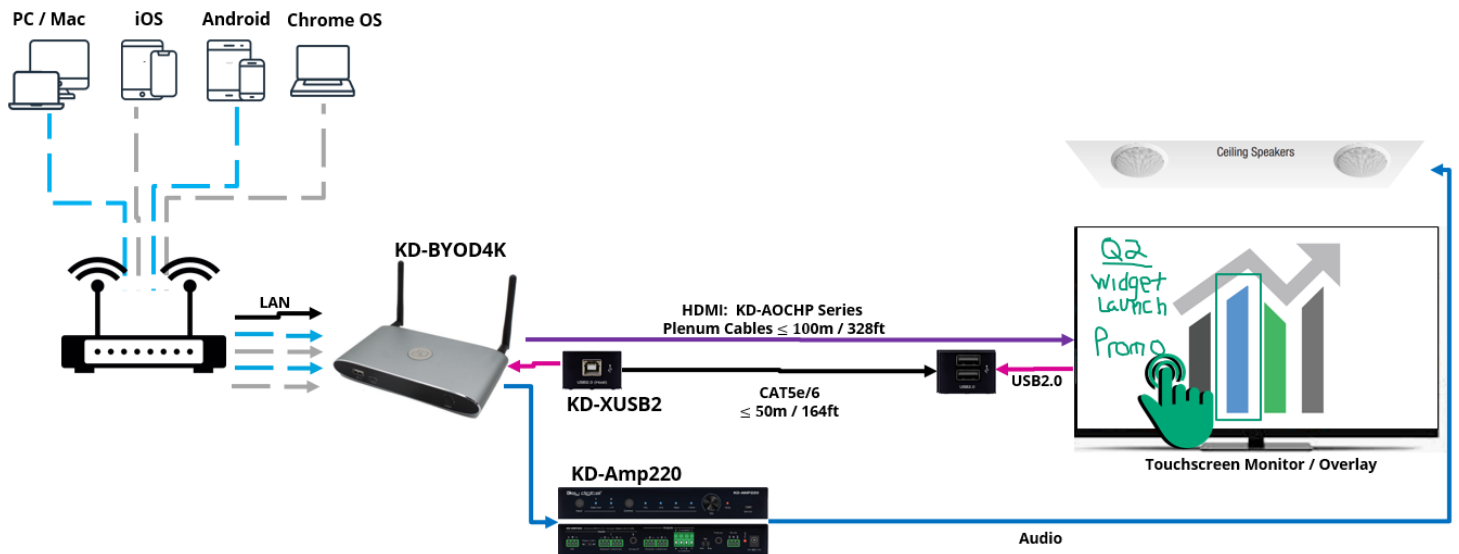

Dual Monitor / Extended Monitor Conferencing System

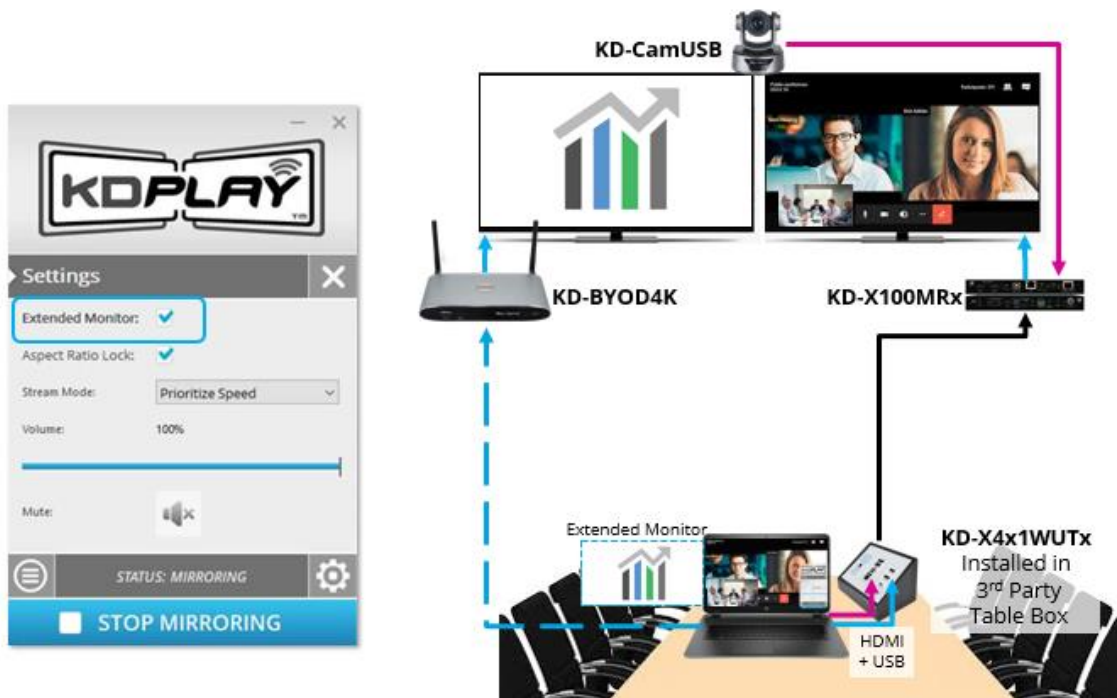

Integration with Key Digital Complete Presentation Solution

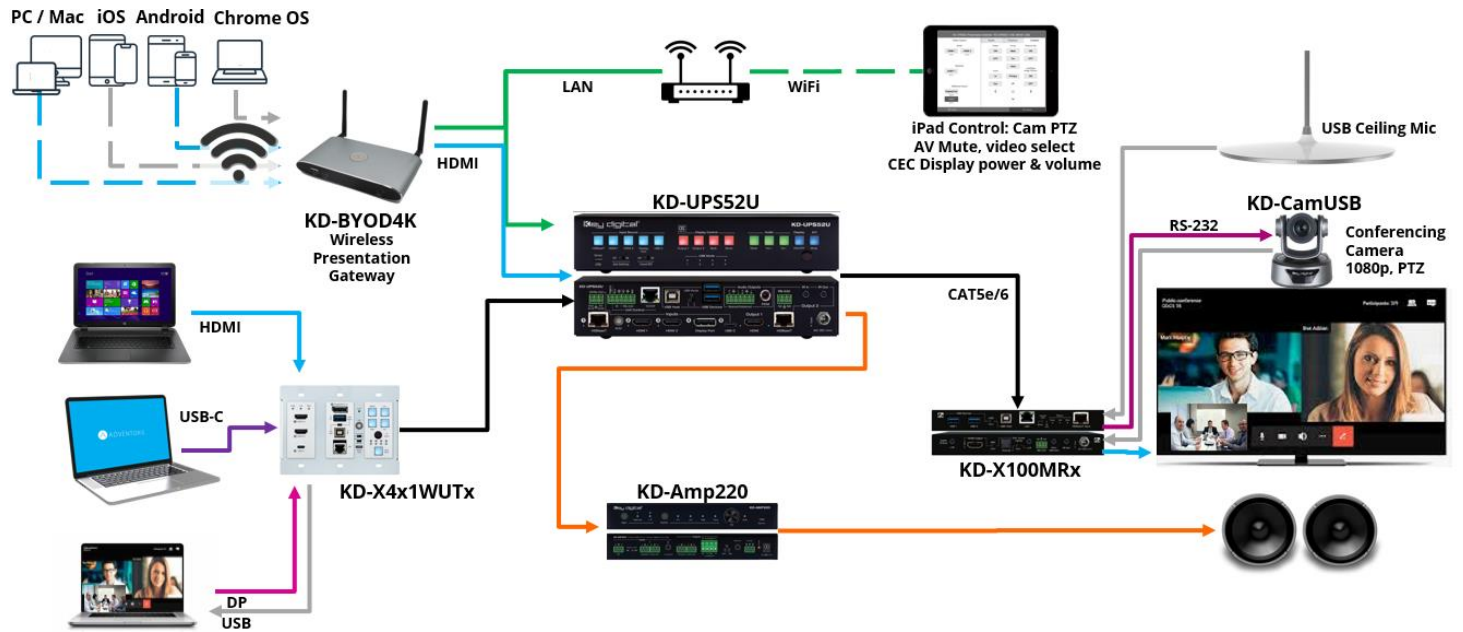

Admin Menu Walkthrough

Log into the web UI by entering the unit's IP address as shown on the HDMI connected monitor into your web browser and selected **ADMIN ACCESS**, then entering the admin password.

1A: Network – Network Mode

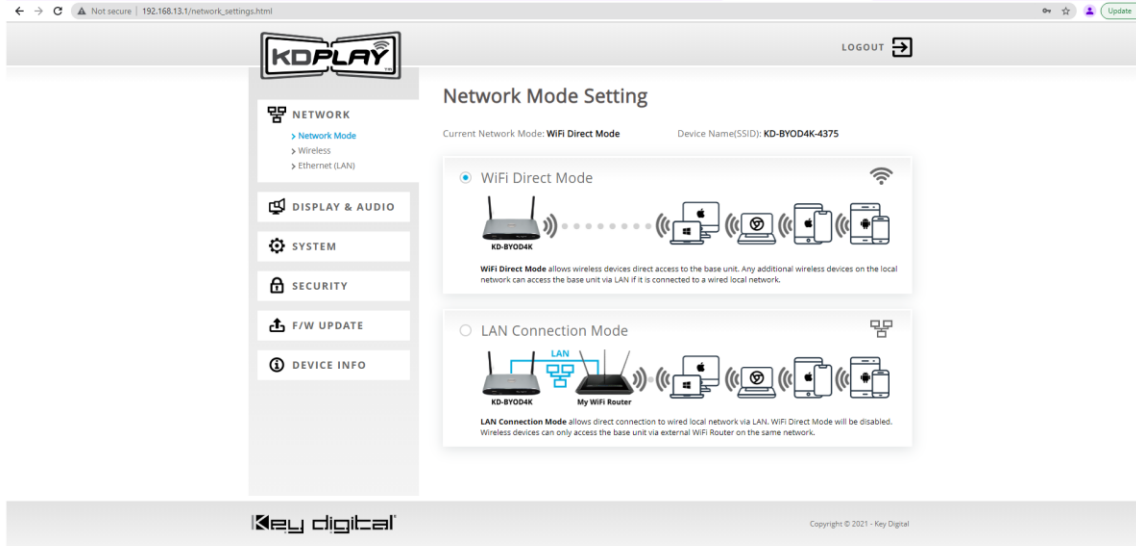

1B: Network – Wireless (WIFI Direct Mode)

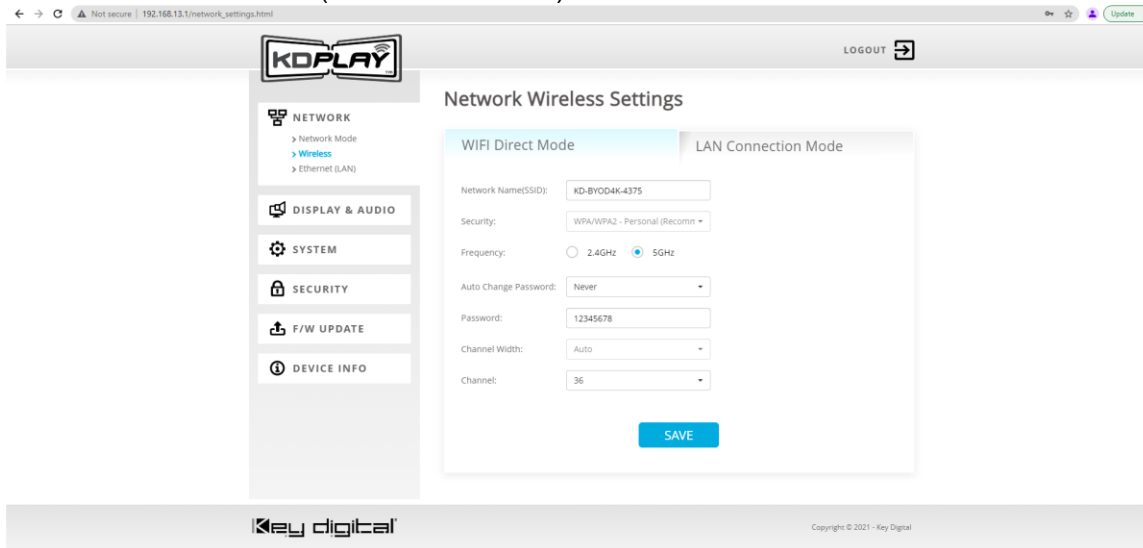

1C: Network – Wireless (LAN Connection Mode)

← → ↻ Not secure | 192.168.13.1/network_settings.html ☆ Update

KDPLAY LOGOUT

NETWORK

- > Network Mode
- > **Wireless**
- > Ethernet (LAN)

DISPLAY & AUDIO

SYSTEM

SECURITY

F/W UPDATE

DEVICE INFO

Network Wireless Settings

WIFI Direct Mode | LAN Connection Mode

KD-BYOD4K Name(SSID): KD-BYOD4K-4375

KD-BYOD4K Password: 12345678

Note: You must connect a network cable to the KD-BYOD4K unit.

Frequency: 2.4GHz 5GHz

WIRELESS SCANNER

SSID: --

Password: **CONNECT**

Connection: No Connection

SAVE

Key digital Copyright © 2021 - Key Digital



1D: Network – Ethernet (LAN)

← → ↻ Not secure | 192.168.13.1/network_settings.html ☆ Update

KDPLAY LOGOUT

NETWORK

- > Network Mode
- > Wireless
- > **Ethernet (LAN)**

DISPLAY & AUDIO

SYSTEM

SECURITY

F/W UPDATE

DEVICE INFO

Ethernet(LAN) Setting

LAN1 | LAN2

Obtain IP Address Automatically Use the following IP address:

IP Address: 0.0.0.0

Subnet Mask: 0.0.0.0

Default Gateway: 0.0.0.0

DNS1: 0.0.0.0

DNS2: 0.0.0.0

MAC Address: 60:89:B1:37:11:17

SAVE

Key digital Copyright © 2021 - Key Digital



2A: Display Audio - HDMI Output

← → ↻ Not secure | 192.168.13.1/display_settings.html ☆ Update

KDPLAY LOGOUT

NETWORK

DISPLAY & AUDIO

- > HDMI Output
- > Audio Output
- > Airplay Picture Quality
- > On-Screen Display
- > Home Screen Background
- > Multiview Layout

SYSTEM

SECURITY

F/W UPDATE

DEVICE INFO

Display & Audio Settings

HDMI Output

HDMI Resolution:

- Auto
- 1920x1080@60
- 1920x1080@50
- 1280x720@60
- 1280x720@50

Key digital Copyright © 2021 - Key Digital



2B: Display Audio – Audio Output

← → ↻ Not secure | 192.168.13.1/display_settings.html ☆ Update

KDPLAY LOGOUT

NETWORK

DISPLAY & AUDIO

- > HDMI Output
- > Audio Output
- > Airplay Picture Quality
- > On-Screen Display
- > Home Screen Background
- > Multiview Layout

SYSTEM

SECURITY

F/W UPDATE

DEVICE INFO

Display & Audio Settings

Audio Output

Audio Output:

Audio Volume: Audio Mute

Key digital Copyright © 2021 - Key Digital



2C: Display Audio – Airplay Picture Quality

The screenshot shows a web browser window with the URL `192.168.13.1/display_settings.html`. The page features a navigation menu on the left with categories: NETWORK, DISPLAY & AUDIO (with sub-items: HDMI Output, Audio Output, Airplay Picture Quality, On-Screen Display, Home Screen Background, Multiview Layout), SYSTEM, SECURITY, F/W UPDATE, and DEVICE INFO. The main content area is titled 'Display & Audio Settings' and contains a section for 'AirPlay Picture Quality'. A dropdown menu is open, showing four options: 'High(1920x1080)', 'High(1920x1080)', 'Medium(1280x720)', and 'Low(1136x640)'. The top right of the page has a 'LOGOUT' button. The footer includes the 'Key digital' logo and 'Copyright © 2021 - Key Digital'.



2D: Display Audio – On-Screen Display

The screenshot shows the same web browser window as above, but with the 'On-Screen Display' settings selected. The 'Airplay Picture Quality' dropdown is now closed. The 'On-Screen Display' section contains two checkboxes: 'Show base unit info when mirroring' (unchecked) and 'Show mirroring device info when mirroring' (checked). The rest of the interface, including the navigation menu and footer, remains the same.



2E: Display Audio – Home Screen Background

← → ↻ Not secure | 192.168.13.1/display_settings.html ☆ Update

KDPLAY LOGOUT

NETWORK

DISPLAY & AUDIO

- > HDMI Output
- > Audio Output
- > Airplay Picture Quality
- > On-Screen Display
- > **Home Screen Background**
- > Multiview Layout

SYSTEM

SECURITY

F/W UPDATE

DEVICE INFO

Display & Audio Settings

Home Screen Background

Lock instructional banner when using custom background image

Notes:

- Custom image must be 1920x1080 resolution with 72 dpi.
- Instructional banner is 73 pixels tall. You may need to adjust the vertical centering of your custom image if instructional banner is locked.

Key digital Copyright © 2021 - Key Digital



2F: Display Audio – Multiview Layout

← → ↻ Not secure | 192.168.13.1/display_settings.html ☆ Update

KDPLAY LOGOUT

NETWORK

DISPLAY & AUDIO

- > HDMI Output
- > Audio Output
- > Airplay Picture Quality
- > On-Screen Display
- > Home Screen Background
- > **Multiview Layout**

SYSTEM

SECURITY

F/W UPDATE

DEVICE INFO

Multiview Layout Settings

Multiview Layout

Layout with 3 casting devices

Layout with 4 casting devices

Key digital Copyright © 2021 - Key Digital



3A: System – Mirroring Info

Browser address bar: 192.168.13.1/system_settings.html

Page Title: Mirroring Info

Navigation: NETWORK, DISPLAY & AUDIO, SYSTEM, SECURITY, F/W UPDATE, DEVICE INFO

System Settings:

- Mirroring Info
- Time Settings
- Auto Standby
- Factory Restore
- Chromecast Settings

Table: Connected Devices / Paired Devices

Device type	Device Name	Serial number	Device version	Status	Last Log	Operation
No matching records found						

Note: AirPlay devices are not shown in above Connected & Paired devices list

Footer: Key digital, Copyright © 2021 - Key Digital



3B: System – Time Settings

Browser address bar: 192.168.13.1/system_settings.html

Page Title: System Settings

Navigation: NETWORK, DISPLAY & AUDIO, SYSTEM, SECURITY, F/W UPDATE, DEVICE INFO

System Settings:

- Mirroring Info
- Time Settings
- Auto Standby
- Factory Restore
- Chromecast Settings

Time Settings

Auto Date & Time: Use network-provided time

Date: 2021-07-06

Time: 06:55:34

Time Zone: GMT-04:00 Eastern Daylight

Note: Time will only be displayed with a LAN cable and internet connection into KD-BYOD4K. Casting from Chrome OS requires connection to an internet-enabled network with KD-BYOD4K time settings set to Use Network-Provided Time and the appropriate time zone selected.

SAVE

Footer: Key digital, Copyright © 2021 - Key Digital



3C: System - Auto Standby

The screenshot shows a web browser window with the URL 192.168.13.1/system_settings.html. The page features the KDPLAY logo and a navigation menu on the left with categories: NETWORK, DISPLAY & AUDIO, SYSTEM (with sub-items: Mirroring Info, Time Settings, Auto Standby, Factory Restore, Chromecast Settings), SECURITY, F/W UPDATE, and DEVICE INFO. The main content area is titled 'System Settings' and contains the 'Auto Standby' section. A dropdown menu is open, showing options: Never, 5 minutes, 30 minutes, 1 hour, 2 hour, and 4 hour. The current selection is 'Never'. A 'LOGOUT' button is visible in the top right corner. The footer contains the Key digital logo and 'Copyright © 2021 - Key Digital'.



3D: System – Factory Restore

The screenshot shows the same web browser window as in 3C, but with the 'Factory Restore' option selected in the left navigation menu. The main content area is titled 'System Settings' and contains the 'Factory Restore' section. It includes the text 'Revert all settings to factory defaults.' and a prominent blue 'FACTORY RESTORE' button. The 'LOGOUT' button remains in the top right corner. The footer contains the Key digital logo and 'Copyright © 2021 - Key Digital'.



3E: System - Chromecast Settings

← → ⌂ Not secure | 192.168.13.1/system_settings.html

KDPLAY LOGOUT

SYSTEM

- > Mirroring Info
- > Time Settings
- > Auto Standby
- > Factory Restore
- > **Chromecast Settings**

Chrome OS Settings

Casting from Chrome OS / Browser

Enable Chromecast

Note: For Chrome OS support, KD-BYOD4K must be on an internet-enabled network and the KD-BYOD4K time settings must be set to Use Network-Provided Time with the appropriate time zone selected. Power cycle KD-BYOD4K if time settings and/or network connection are updated.

Key digital Copyright © 2021 - Key Digital



4A: Security – Security Level

← → ⌂ Not secure | 192.168.13.1/security_settings.html

KDPLAY LOGOUT

SECURITY

- > **Security level**
- > Login password

Security Settings

Security Level

#	Security Item	Level 1	Level 2	Level 3	Preference
1	Enable login password for Webpage	✓	✓	✓	✓
2	Auto-change password for Wireless	✓	✓	✓	✓
3	Encryption of Data: Proprietary	✓	✓	✓	✓
4	Enable "Airplay" PIN code		✓	✓	<input type="checkbox"/>
5	Enable login password for Telnet		✓	✓	<input type="checkbox"/>
6	Encryption of Data: AES-256 Bit + RSA-1024Bit		✓	✓	<input type="checkbox"/>
7	Disable Android APK Airplay			✓	<input type="checkbox"/>
8	Disable "Firmware downgrade"			✓	<input type="checkbox"/>

Current Security Level: Level 1 Level 2 Level 3 Preference

SAVE

Key digital Copyright © 2021 - Key Digital



4B: Security – Login Password

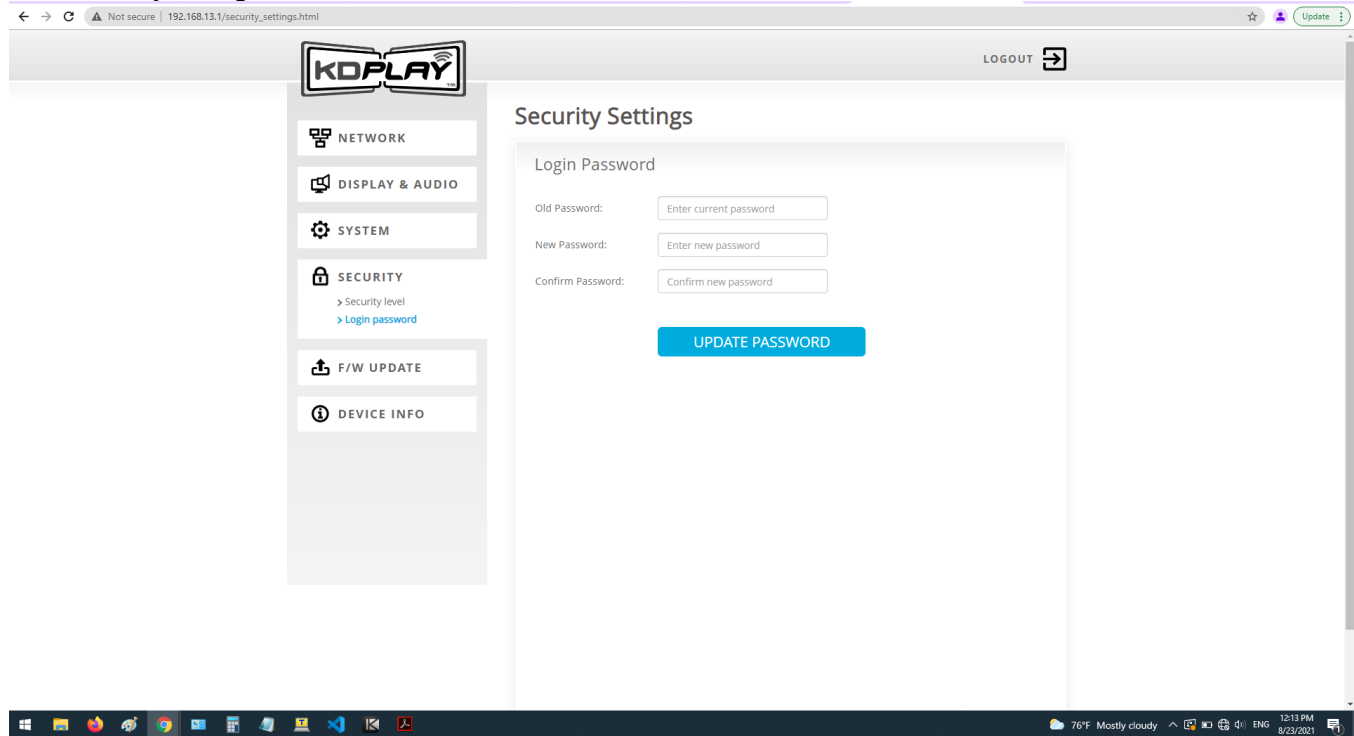

5A: FW Update – Firmware Update

NOTE: Firmware update via Web UI is currently disabled. Please contact Key Digital Technical Support to receive the latest firmware and instructions on how to update.

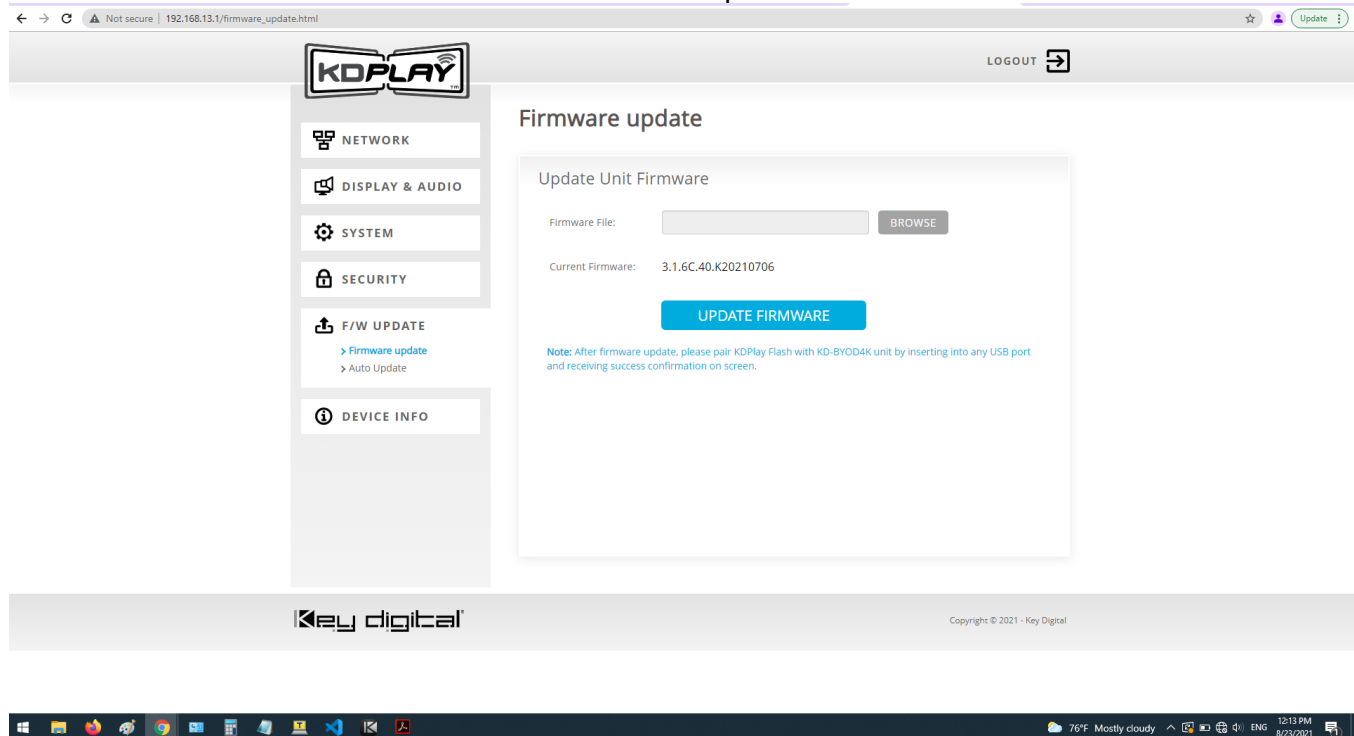

5B: FW Update – Auto Update

The screenshot shows a web browser window with the URL `192.168.13.1/firmware_update.html`. The page features the KDPLAY logo at the top left and a 'LOGOUT' button at the top right. A left-hand navigation menu includes categories: NETWORK, DISPLAY & AUDIO, SYSTEM, SECURITY, F/W UPDATE (with sub-items 'Firmware update' and 'Auto Update'), and DEVICE INFO. The main content area is titled 'Firmware update' and contains a section for 'Auto Update' with a checked checkbox and a note: 'Note: Auto update requires LAN Connection with an internet enabled network.' The footer contains the 'Key digital' logo and 'Copyright © 2021 - Key Digital'. The Windows taskbar at the bottom shows the date as 8/23/2021 and the time as 12:14 PM.

6A: Device Info

The screenshot shows a web browser window with the URL `192.168.100.12/about_device.html`. The page features the KDPLAY logo at the top left and a 'LOGOUT' button at the top right. A left-hand navigation menu includes categories: NETWORK, DISPLAY & AUDIO, SYSTEM, SECURITY, F/W UPDATE, and DEVICE INFO (with a sub-item 'About device'). The main content area is titled 'Device Info' and contains a section for 'KDPlay Device Info' with the following details:

Model name	KD-BYOD4K
Device Name(SSID)	KD-BYOD4K-4540
Firmware version	3.1.6C.40.K20230802
Web server version	1.21
WIFI MAC	D4:12:43:B0:B2:5A

The footer contains the 'Key digital' logo and 'Copyright © 2021 - Key Digital'. The Windows taskbar at the bottom shows the date as 8/23/2021 and the time as 12:14 PM.

Warranty Information

All Key Digital® products are built to high manufacturing standards and should provide years of trouble-free operation. They are backed by a Key Digital Limited 3 Year Product Warranty Policy.

<http://www.keydigital.com/warranty.htm>

Product Warnings & Safety Instructions



Important Product Warnings:

1. Connect all cables before providing power to the unit.
2. Test for proper operation before securing unit behind walls or in hard to access spaces.
3. If installing the unit into wall or mounting bracket into sheet-rock, provide proper screw support with bolts or sheet-rock anchors.



Safety Instructions:

Please be sure to follow these instructions for safe operation of your unit.

1. Read and follow all instructions.
2. Heed all warnings.
3. Do not use this device near water.
4. Clean only with dry cloth.
5. Install in accordance with the manufacturer's instructions.
6. Do not install near any heat sources such as radiators, heat registers, stoves, or other apparatus (including amplifiers) that produce heat.
7. Only use attachments/accessories specified by the manufacturer.
8. Refer all servicing to qualified service personnel. Servicing is required when the device has been damaged in any way including:
 - Damage to the power supply or power plug
 - Exposure to rain or moisture



Power Supply Use:

You MUST use the Power Supply provided with your unit or you VOID the Key Digital® Warranty and risk damage to your unit and associated equipment.